

# VITOLUPO

ITALIAN ARTDESIGN

## GLI OLMI

TAVOLINI | SMALL TABLES

by Fabio Crippa & Joe Gentile



Il disegno a intarsio geometrico viene ripreso sul top. Anche il basamento è disegnato utilizzando questa modalità progettuale. Le linee sottili e decise in ottone cromo nero si sposano appieno con le linee geometriche del top.

The geometric inlay design appears on the tabletop and the base. The slender, clean lines in black-chromed brass are well-matched with the geometric lines of the tabletop.



# GLI OLMI

## TAVOLINO BASSO QUADRATO | SQUARE COFFEE TABLE

dimensioni | dimensions L95 x P95 x H41 cm  
peso | weight 70 kg  
volume | volume 0,56 m<sup>3</sup>

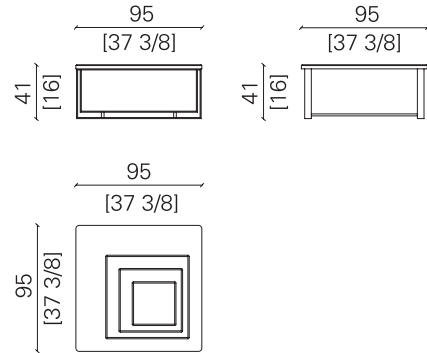

Tavolino basso quadrato con struttura in ottone in finitura cromo nero lucido e piano in marmo Nero Marquina con intarsio bianco in contrasto.

Square coffee table with shiny black chromed brass structure, and top in Nero Marquina marble, with contrasting white inlay.

### finiture | finishes

piano in marmo alleggerito con inserto in contrasto  
lightened marble top with contrasting inserts

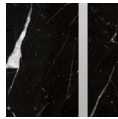

**MA.N01**  
Nero Marquina  
con inserto  
bianco  
with white insert

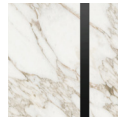

**MA.B01**  
Calacatta  
Vagli Oro con  
inserto nero  
with black insert

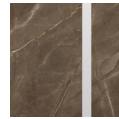

**MA.T02**  
Bronze Amani  
con inserto  
bianco  
with white insert

struttura in ottone  
brass structure



**ME01**  
bronzato  
bronzed



**ME02**  
bagno oro  
lucido  
shiny gold  
plated



**ME03**  
satinato  
satin finish

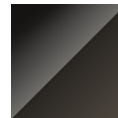

**ME04**  
cromo nero lucido  
shiny black chrome

### composizioni | compositions

Finitura come da immagine.  
Finish as shown in image.

Altre finiture disponibili su richiesta. | Other finishes available upon request.

# GLI OLMI

## TAVOLINO BASSO RETTANGOLARE | RECTANGULAR COFFEE TABLE

dimensioni | dimensions L140 x P80 x H41 cm  
peso | weight 77 kg  
volume | volume 0,70 m<sup>3</sup>

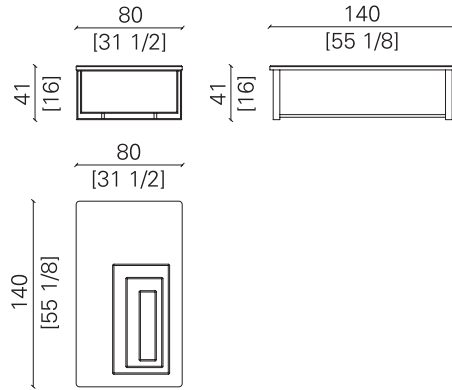

Tavolino basso rettangolare con struttura in ottone in finitura cromo nero lucido e piano in marmo Nero Marquina con intarsio bianco in contrasto.

Rectangular coffee table with shiny black chromed brass structure, and top in Nero Marquina marble, with contrasting white inlay.

### finiture | finishes

piano in marmo alleggerito con inserto in contrasto  
lightened marble top with contrasting inserts

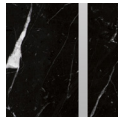

**MA.N01**  
Nero Marquina  
con inserto  
bianco  
with white insert

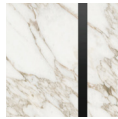

**MA.B01**  
Calacatta  
Vagli Oro con  
inserto nero  
with black insert

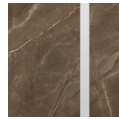

**MA.T02**  
Bronze Amani  
con inserto  
bianco  
with white insert

struttura in ottone  
brass structure



**ME01**  
bronzato  
bronzed



**ME02**  
bagno oro  
lucido  
shiny gold  
plated



**ME03**  
satinato  
satin finish

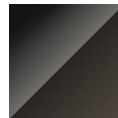

**ME04**  
cromo nero lucido  
shiny black chrome

### composizioni | compositions

Finitura come da immagine.  
Finish as shown in image.

Altre finiture disponibili su richiesta. | Other finishes available upon request.

# GLI OLMI

## TAVOLINO ALTO | SMALL TABLE

dimensioni | dimensions L45 x P45 x H65 cm  
peso | weight 40 kg  
volume | volume 0,23 m<sup>3</sup>

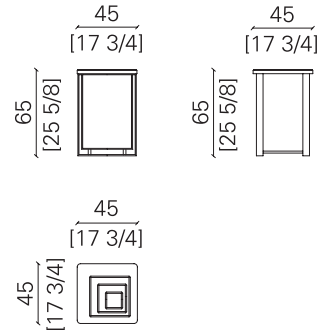

Tavolino alto con struttura in ottone in finitura cromo nero lucido e piano in marmo Nero Marquina con intarsio bianco in contrasto.

Small table with shiny black chromed brass structure, and top in Nero Marquina marble, with contrasting white inlay.

### finiture | finishes

piano in marmo alleggerito con inserto in contrasto  
lightened marble top with contrasting inserts

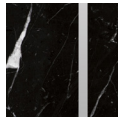

**MA.N01**  
Nero Marquina  
con inserto  
bianco  
with white insert

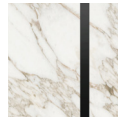

**MA.B01**  
Calacatta  
Vagli Oro con  
inserto nero  
with black insert

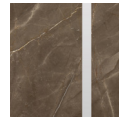

**MA.T02**  
Bronze Amani  
con inserto  
bianco  
with white insert

struttura in ottone  
brass structure



**ME01**  
bronzato  
brass



**ME02**  
bagno oro  
lucido  
shiny gold  
plated



**ME03**  
satinato  
satin finish

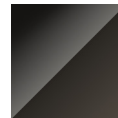

**ME04**  
cromo nero lucido  
shiny black chrome

### composizioni | compositions

Finitura come da immagine.  
Finish as shown in image.

Altre finiture disponibili su richiesta. | Other finishes available upon request.