

VITOLUPO

ITALIAN ARTDESIGN

LA BETULLA

POLTRONA | ARMCHAIR

by Fabio Crippa & Joe Gentile



L'utilizzo duttile delle linee scultoree rende morbido il profilo della poltroncina, arricchito anche dalla presenza del materiale lapideo. Gli intarsi geometrici in marmo bianco, in contrasto con la scocca in Marquina Nero, ne esaltano la leggerezza, mentre il marmo assume le qualità estetiche di un tessuto ricamato. L'imbottito lavorato a capitoné rimanda a sedute di sapore classico che ben si sposano con la struttura più rigida della scocca.

The supple plasticity of the lines softens the outline of the armchair, also enriched by the presence of stone details. The geometric inlays in white marble, contrasting with Nero Marquina marble framework, highlight its lightness, while the marble takes on the aesthetic qualities of an embroidered fabric. The padded, capitoné cushions recall a classical style of seating that pairs well with the stony structure.

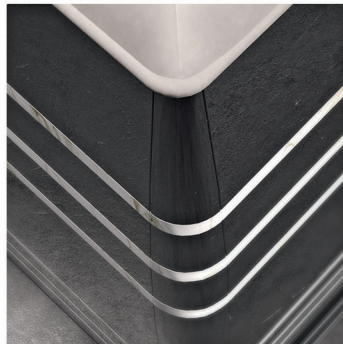

LA BETULLA

POLTRONA | ARMCHAIR

dimensioni | dimensions L83 x P76 x H75 cm
peso | weight 110 kg
volume | volume 0,70 m³

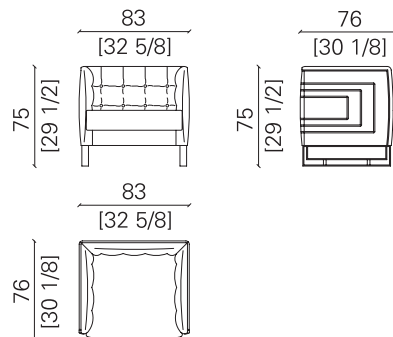

Poltrona con struttura in marmo Nero Marquina con inserti in marmo in contrasto, imbottitura interna in pelle con lavorazione schienale in capitonnè eseguita a mano. Basamento in ottone in finitura cromo nero lucido. Imbottitura in poliuretano espanso a densità differenziata con rivestimento in fibra acrilica.

Armchair with Nero Marquina marble structure and contrasting marble inserts, upholstered internally in leather, with hand-crafted capitonnè backrest. Base in shiny black chromed brass. Padding in foam polyurethane of varying density, with acrylic fiber cover.

finiture | finishes

struttura in marmo con inserto in contrasto
marble structure with contrasting inserts

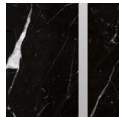

MA.N01
Nero Marquina
con inserto bianco
with white insert

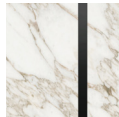

MA.B01
Calacatta Vagli Oro
con inserto nero
with black insert

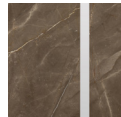

MA.T02
Bronze Amani
con inserto bianco
with white insert

seduta imbottita in pelle
seat upholstered in leather

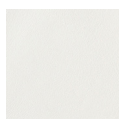

ZF1870
pelle
leather

+ altri colori
+ other colours

basamento in ottone
base in brass



ME01
bronzato
bronzed



ME02
bagno oro
lucido
shiny gold
plated



ME03
satinato
satin finish



ME04
cromo nero lucido
shiny black chrome

composizioni | compositions

Finitura come da immagine.
Finish as shown on image.

Altre finiture disponibili su richiesta. | Other finishes available upon request.

LA BETULLA

POLTRONA | ARMCHAIR

cuscini | cushions

cuscino strutturale
50x50 cm x 1pz
structural cushion
50x50 cm x 1 pc

Imbottitura cuscini in piuma d'oca. Profilo in tinta o in contrasto.
Ducks' down cushion filling. Matching or contrasting piping.

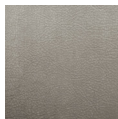

+ altri colori
+ other colours

ZF1870
pelle
leather

Altre finiture disponibili su richiesta. | Other finishes available upon request.